

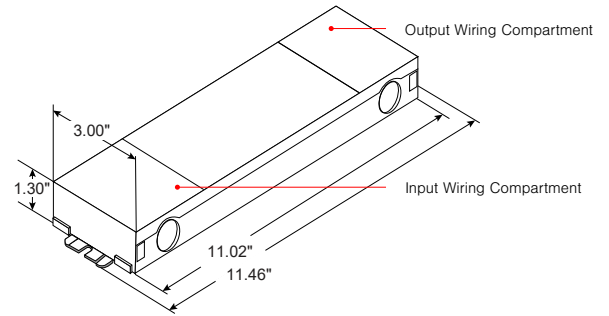

# iQ-ND-96-20 & iQ-D010-96-20

iQ-ND-96-20 and iQ-D010-96-20 are Q-Tran's newest interior rated, surface mounted, easy to use power supply. The power supply is rated IP20, interior use only. The driver is a non-dimmable power supply with an optional 0-10V dimming module in the secondary compartment. The output voltage is 24VDC constant voltage and this driver is capable of powering up to 96W of load. This easy to use driver is great for simple jobs that need a high quality, low cost solution.



## FEATURES

- Limited output voltage and current, plus isolation for safe operation
- Dimmable w/ additional 0-10V Dimming Module
- Fully potted driver(s) for moisture resistance
- Surface mount only
- Suitable for dry and damp locations
- Suitable for Indoor use
- Primary Voltage - Universal (120-277V )
- Wide operating temperature range: -20 degF to +140 degF
- Class 2
- UL Listed
- 5 year warranty



## PERFORMANCE

### Power Supply



- : Rated for surface mount
- : Fully rated to operate low voltage load at listed wattage (No Derating Required)
- : Voltage regulation to 2% or less of rated output voltage
- : Universal input range of 120-277 Vrms
- : Short circuit protection (SCP)
- : Over voltage protection (OVP)
- : Over current protection (OCP)
- : Live tested by manufacture to ensure proper operation
- : Manufacturer offers minimum of 5 year warranty

## SPECIFICATIONS

\*- 200us event

		24V		
<b>Input</b>	• Input Voltage (Vrms)	120-277		
	• Input current, max (Arms)	0.94/0.41A		
<b>Output</b>	• Inrush Current, max* (Apk)	20A @230V		
	• Input Frequency (Hz)	50/60		
	• Input Power (W)	111		
	• Output Voltage, nom (V)	24		
<b>Environmental</b>	• Output Current (A)	4.0		
	• Output Power (Wmax)	96		
	• Dimming 0-10V, (Max)	2mA		
<b>Protections</b>	• THD (%)	Min	Nom	Max
	• PF (%)	----	----	2.0
	• Case Temp (°C)	0.90	----	----
		----	----	70
<b>Compliance</b>		<ul style="list-style-type: none"> <li>• EMI/RFI : FCC(47CFR, part15) Class B</li> <li>: EN 61000-3-2</li> <li>• Certified : UL/cUL 1316/1430/1585</li> <li>: UL-879</li> <li>: UL-8750</li> </ul>		
 				

## ORDERING GUIDE

1	2	3
Model	Max Output (W)	IP Rating
	96	20
1 Model		
iQ-ND : NonDim		
iQ-D010 : 0-10V Dimming		
2 Max Output		
96: 96W		
3 IP Rating		
20: IP20		
Ordering Example		
iQ-ND-96-20		 
iQ-D010-96-20		

20190225-V1

PROJECT NAME	DATE	COMPANY	TYPE	NOTE



iQ-ND-96-20 & iQ-D010-96-20

# SPECIFICATIONS & WIRING DIAGRAM

### Lifetime vs Case Temperature

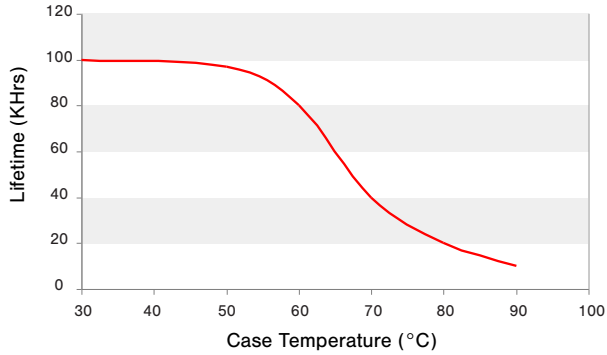

## NON DIMMING

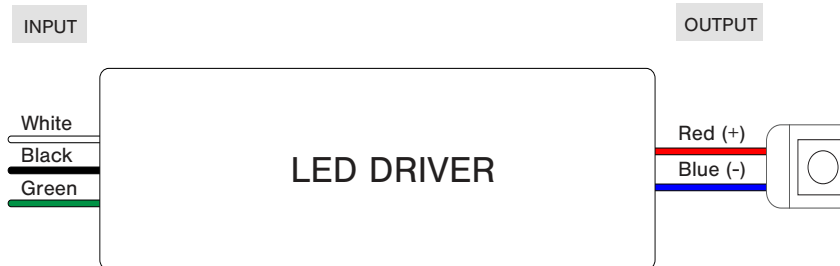

## 0-10V DIMMING

