



iQLED TAPE LIGHT **5050 CHIP SERIES**
iQ67 2.6 W/ft: WET RATED



Q-Tran's iQ67 flexible LED tape light is wet listed and available in multiple color temperatures ranging from 2500K – 4000K. The 2.6 W/Ft utilizes the 5050 chip, can come in a 35' reel, has cut points of 6.57", can be cut to length in the field or cut to length at the Q-Tran factory. The lumen output of this LED makes it perfect for most exterior or interior application where a coated LED is required.

iQ67	-		-	50	-	90	-	2.6	
iQ Series		Color Temp		Chip		CRI		Watts Per FT	Length

FEATURES

- LED life time - 40,000 hours
- Operating temperature: -4°F ~ +113°F
- Suitable for dry, damp or wet locations
- Non-Ferrous Material
- 6.57" cut points
- Field cuttable
- 3 year Warranty

iQ67-25-50-90-2.6

Max Run / Reel Length: 35ft* | ColorTemp: 2500K | Voltage: 24VDC
 CRI: 90+ | LM: 79 | Watts Per Ft: 2.6 | Lumens Per Ft: 150

iQ67-27-50-90-2.6

Max Run / Reel Length: 35ft* | ColorTemp: 2700K | Voltage: 24VDC
 CRI: 90+ | LM: 79 | Watts Per Ft: 2.6 | Lumens Per Ft: 155

iQ67-30-50-90-2.6

Max Run / Reel Length: 35ft* | ColorTemp: 3000K | Voltage: 24VDC
 CRI: 90+ | LM: 79 | Watts Per Ft: 2.6 | Lumens Per Ft: 196

iQ67-35-50-90-2.6

Max Run / Reel Length: 35ft* | ColorTemp: 3500K | Voltage: 24VDC
 CRI: 90+ | LM: 79 | Watts Per Ft: 2.6

iQ67-40-50-90-2.6

Max Run / Reel Length: 35ft* | ColorTemp: 4000K | Voltage: 24VDC
 CRI: 90+ | LM: 79 | Watts Per Ft: 2.6 | Lumens Per Ft: 216

*Maximum length for one run of iQ67 LED 2.6. Individual Power supply cut sheets will provide max distance/loads per power supply.

COMPATIBLE EXTRUSIONS

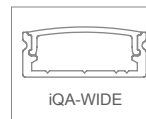

NOTE: Can be used in wet locations.

COMPATIBLE POWER SUPPLIES

Interior Applications

- QJB-DC
- QJBL-DC
- QJBL-DC+CAP
- Q6S-DC
- Q6M-DC+CAP
- QTM-DC
- QTM-DC+CAP
- QTM-eLED
- QTM-eLED(L)
- QTM-eLED(E)
- iQ-PH

Exterior Applications

- QOM-eLED
- QOM-DC
- QOM-DC+CAP
- Q-SET-eLED
- Q-SET-mLED
- Q-HEX-Mini-DC
- iQ-PH

DIMENSIONS

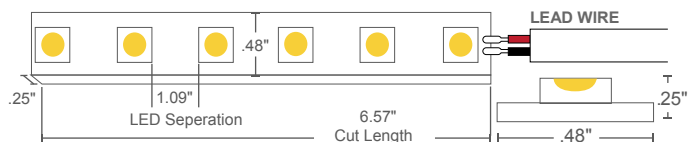

- NOTE**
- Q-Tran offers multiple LED Chip offerings based upon size and pitch, each utilizing its own binning. Utilization of multiple outputs within the same chip family will ensure flawless color matching and similar overall diffusion.
 - Field modifications of factory installed LEDs are not covered under Q-Tran warranty.



Cut marks of LED tape allows for changes in the field.
2.6 watts per foot = cut every 6.57"
 Lead wire comes standard on all LEDs in 18" (18/2 AWG)

2017.V02

PROJECT NAME	DATE	COMPANY	TYPE	NOTE



iQ LED PHOTOMETRIC

iQ67 2.6 W/Ft

iQ67-25-50-90-2.6

Light efficiency:

58 Lumen/Watt

CRI:

92.1

Color temperature:

2387K

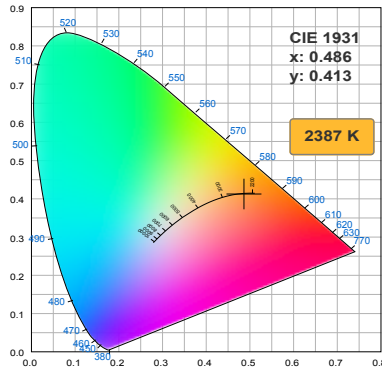
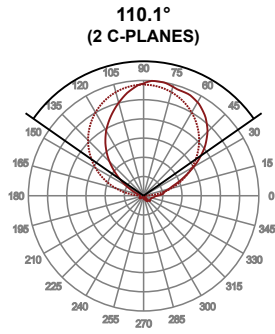

Electrical Test Condition for 1 foot

Output: 150 lm/ft **Peak:** 50.6 cd **Power:** 2.6 W/ft **24V@ 0.11A**

COLOR PARAMETERS

CCT	CRI	CRI R9	TM30 Rf	TM30 Rg	CQS	x	y	u	v	Δuv
2387 K	92.1	61.9	88.9	102.3	86.3	0.486	0.413	0.279	0.355	0.0006

CRI R Values, only R1-R8 are used to calculate final CRI value

R1	R2	R3	R4	R5	R6	R7	R8	R9	R10	R11	R12	R13	R14	R15
92.9	95.1	94.7	92.8	91.7	94.3	92.4	82.6	61.9	86.5	93.2	82.1	93.4	95.6	89.1

BEAM DETAILS

Beam angle 50%	Field angle 50%	Cutoff angle 2.5%	Intensity ratio in 120°cone	Intensity ratio in 90°cone
110.1°	164.6°	245.5°	72.7%	49.6%

Beam Intensities in Footcandles (from 1-20m)

3.3ft	6.6ft	9.8ft	13.1ft	16.4ft	19.7ft	23ft	26.2ft	29.5ft	32.8ft
4.6	1.1	0.5	0.3	0.2	0.1	0.1	0	0.1	0

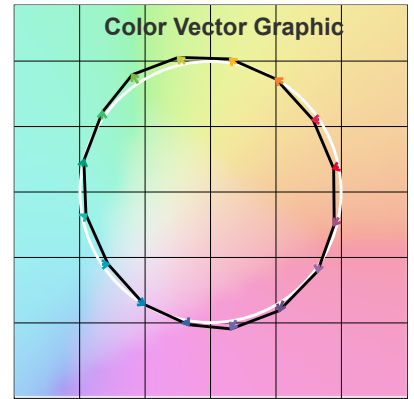

Hue Bin	Rf	Graphics Shift	
		Chroma	Hue
1	90	-4%	-1%
2	90	-4%	3%
3	82	0%	8%
4	88	3%	6%
5	90	6%	5%
6	89	8%	0%
7	87	3%	-6%
8	91	0%	-6%
9	93	-3%	-2%
10	91	-4%	3%
11	89	0%	7%
12	87	3%	4%
13	90	6%	-6%
14	85	5%	-8%
15	90	2%	-6%
16	87	-2%	-8%

iQ67-27-50-90-2.6

Light efficiency:

60 Lumen/Watt

CRI:

92.3

Color temperature:

2609K

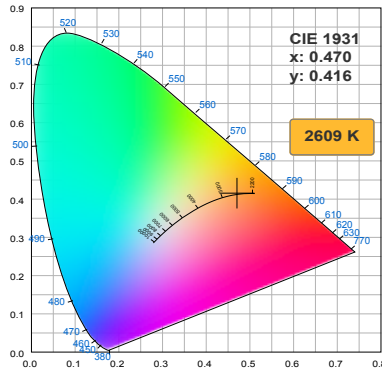
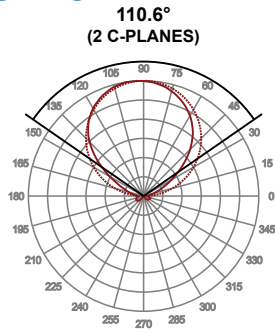

Electrical Test Condition for 1 foot

Output: 155 lm/ft **Peak:** 52.1 cd **Power:** 2.6 W/ft **24V@ 0.11A**

COLOR PARAMETERS

CCT	CRI	CRI R9	TM30 Rf	TM30 Rg	CQS	x	y	u	v	Δuv
2609 K	92.3	58.9	90.1	99.5	89.4	0.470	0.416	0.266	0.354	0.0014

CRI R Values, only R1-R8 are used to calculate final CRI value

R1	R2	R3	R4	R5	R6	R7	R8	R9	R10	R11	R12	R13	R14	R15
93.8	95.0	93.5	94.2	91.9	94.0	93.5	82.6	58.9	85.2	94.5	75.0	94.3	94.7	88.7

BEAM DETAILS

Beam angle 50%	Field angle 50%	Cutoff angle 2.5%	Intensity ratio in 120°cone	Intensity ratio in 90°cone
110.6°	160.9°	231.7°	75.0%	51.8%

Beam Intensities in Footcandles (from 1-20m)

3.3ft	6.6ft	9.8ft	13.1ft	16.4ft	19.7ft	23ft	26.2ft	29.5ft	32.8ft
4.8	1.2	0.5	0.3	0.2	0.1	0.1	0	0.1	0

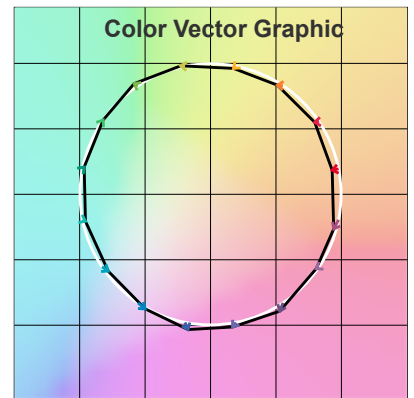

Hue Bin	Rf	Graphics Shift	
		Chroma	Hue
1	90	-5%	0%
2	92	-3%	2%
3	89	-2%	5%
4	92	-2%	2%
5	92	1%	4%
6	93	3%	2%
7	94	0%	-2%
8	97	-1%	-2%
9	93	-2%	2%
10	87	-2%	7%
11	84	1%	9%
12	88	5%	4%
13	91	3%	-4%
14	88	4%	-7%
15	92	-1%	-3%
16	85	-2%	-10%



iQ LED PHOTOMETRIC

iQ67 2.6 W/Ft

iQ67-30-50-90-2.6

Light efficiency:

76 Lumen/Watt

CRI:

93.2

Color temperature:

3101K

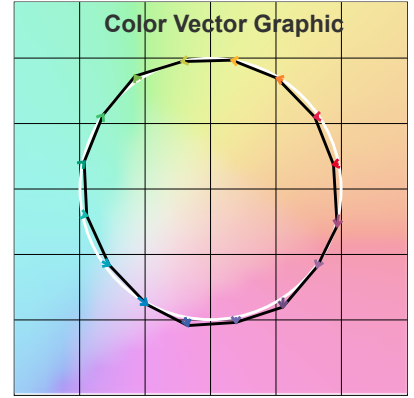
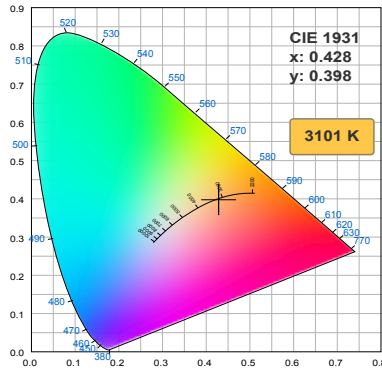
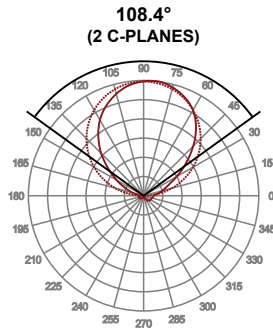

Electrical Test Condition for 1 foot

Output: 196 lm/ft **Peak:** 66.2 cd **Power:** 2.6 W/ft **24V@ 0.11A**

COLOR PARAMETERS

CCT	CRI	CRI R9	TM30 Rf	TM30 Rg	CQS	x	y	u	v	Δuv
3101 K	93.2	70.4	90.0	101.3	90.2	0.428	0.398	0.248	0.345	0.0013

CRI R Values, only R1-R8 are used to calculate final CRI value

R1	R2	R3	R4	R5	R6	R7	R8	R9	R10	R11	R12	R13	R14	R15
94.5	95.3	93.7	93.9	93.0	92.9	94.7	87.9	70.4	86.8	93.4	74.8	94.7	95.5	92.3

BEAM DETAILS

Beam angle 50%	Field angle 50%	Cutoff angle 2.5%	Intensity ratio in 120°cone	Intensity ratio in 90°cone
108.4°	164.2°	236.2°	73.1%	50.7%

Beam Intensities in Footcandles (from 1-20m)

3.3ft	6.6ft	9.8ft	13.1ft	16.4ft	19.7ft	23ft	26.2ft	29.5ft	32.8ft
6.1	1.5	0.7	0.4	0.2	0.2	0.1	0	0.1	0.1

Hue Bin	R _f	Graphics Shift	
		Chroma	Hue
1	92	-4%	0%
2	92	-3%	2%
3	87	-1%	6%
4	92	0%	4%
5	91	0%	3%
6	93	4%	0%
7	93	0%	-2%
8	96	-1%	-2%
9	94	-3%	2%
10	85	-3%	7%
11	82	1%	11%
12	88	6%	4%
13	93	4%	-1%
14	88	6%	-5%
15	90	1%	-5%
16	85	1%	-11%

iQ67-40-50-90-2.6

Light efficiency:

83 Lumen/Watt

CRI:

94.2

Color temperature:

4029K

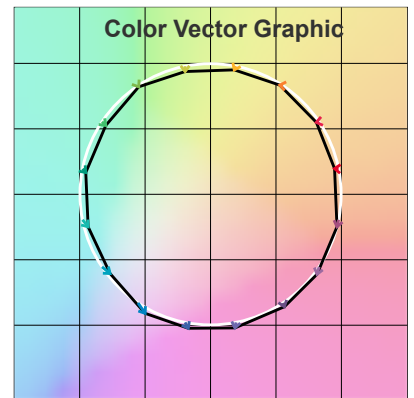
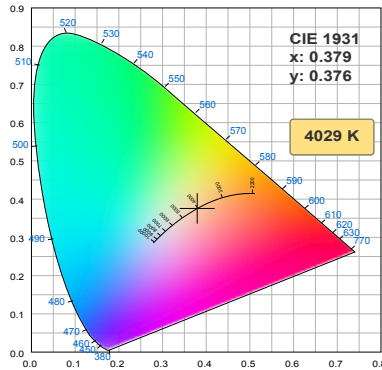
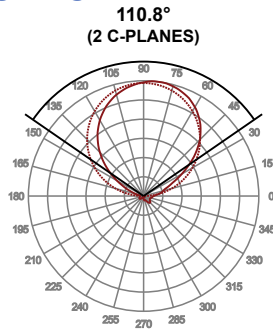

Electrical Test Condition for 1 foot

Output: 216 lm/ft **Peak:** 72.4 cd **Power:** 2.6 W/ft **24V@ 0.11A**

COLOR PARAMETERS

CCT	CRI	CRI R9	TM30 Rf	TM30 Rg	CQS	x	y	u	v	Δuv
4029 K	94.2	77.8	89.2	98.5	91.9	0.379	0.376	0.225	0.334	0.0001

CRI R Values, only R1-R8 are used to calculate final CRI value

R1	R2	R3	R4	R5	R6	R7	R8	R9	R10	R11	R12	R13	R14	R15
95.3	96.4	94.7	94.1	93.1	92.7	96.4	91.3	77.8	89.0	93.5	67.9	95.9	96.4	93.8

BEAM DETAILS

Beam angle 50%	Field angle 50%	Cutoff angle 2.5%	Intensity ratio in 120°cone	Intensity ratio in 90°cone
110.8°	163.7°	246.8°	73.7%	50.6%

Beam Intensities in Footcandles (from 1-20m)

3.3ft	6.6ft	9.8ft	13.1ft	16.4ft	19.7ft	23ft	26.2ft	29.5ft	32.8ft
6.6	1.7	0.7	0.4	0.3	0.2	0.1	0	0.1	0.1

Hue Bin	R _f	Graphics Shift	
		Chroma	Hue
1	91	-3%	1%
2	94	-2%	1%
3	92	-1%	3%
4	91	-3%	1%
5	90	-4%	1%
6	95	-1%	0%
7	93	-4%	1%
8	91	-3%	3%
9	87	-3%	8%
10	81	-2%	10%
11	81	4%	11%
12	89	4%	4%
13	91	4%	-2%
14	93	3%	-1%
15	86	2%	-7%
16	87	0%	-7%

iQ LED TAPE LIGHT COMPATIBLE POWER SUPPLIES

- All DC and mLED Power supplies should be de-rated by 20%**
- DC and mLED power supplies may produce flicker when dimming. For optimal dimming performance, use the iQ-PH or DC+CAP products.

JUNCTION BOX

QJB

QJB-20DC-120/12**

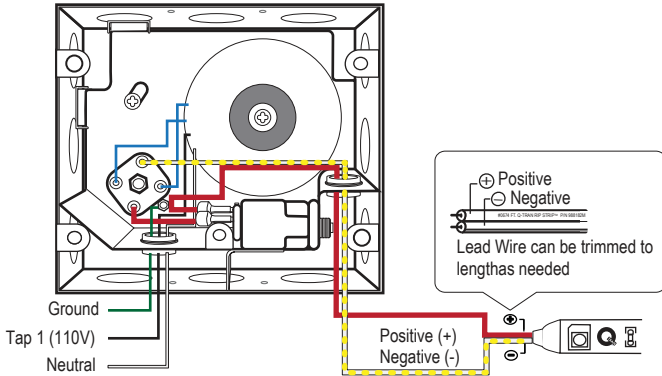

QJB-20DC-120/24**

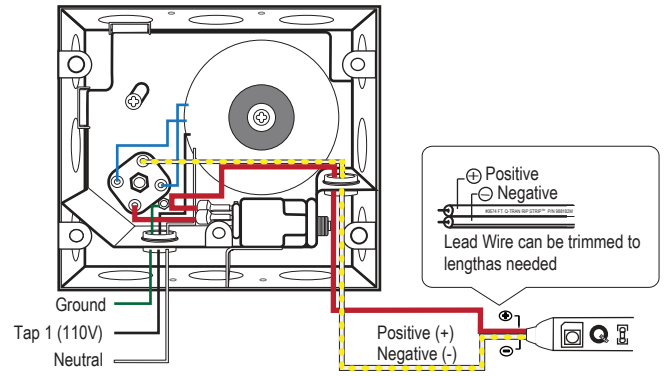

QJBL

QJBL-20DC-120/12**

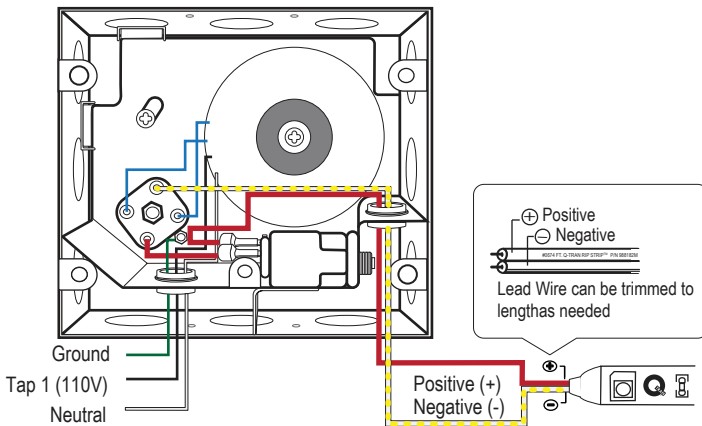

QJBL-20DC-120/24**

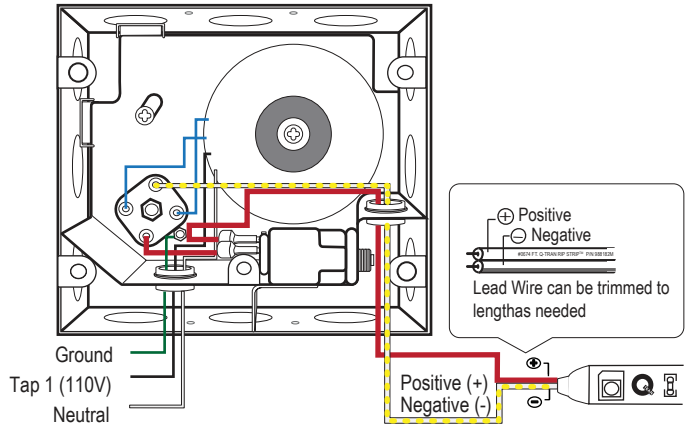

QJBL-40DC-120/24**

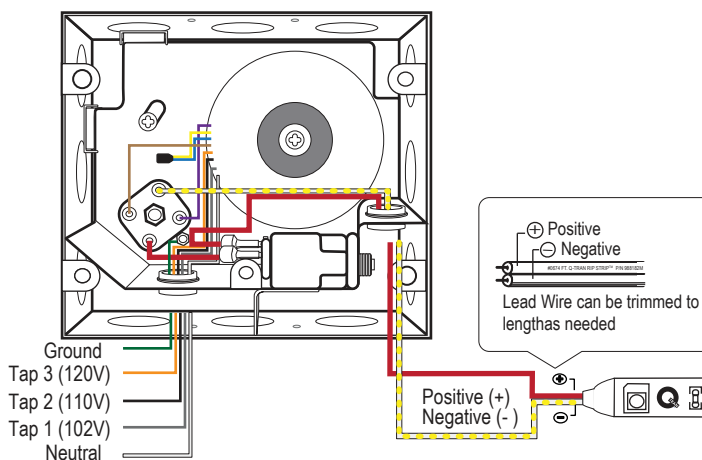

QJBL-20DC+CAP-120/24

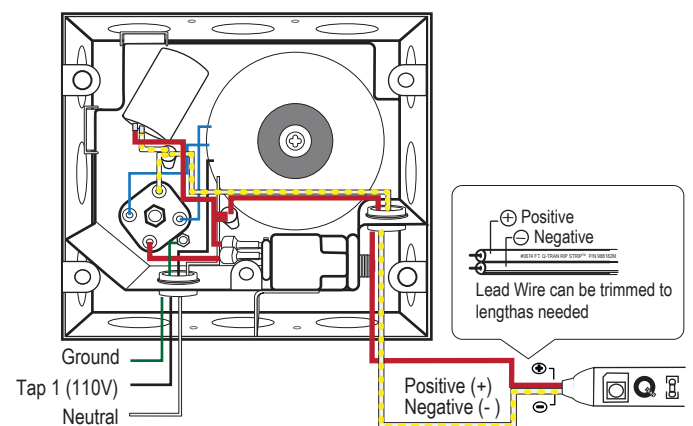

Electronic Driver Non-Dimming

Interior: QTM-eLED
Exterior: QOM-eLED

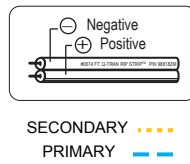
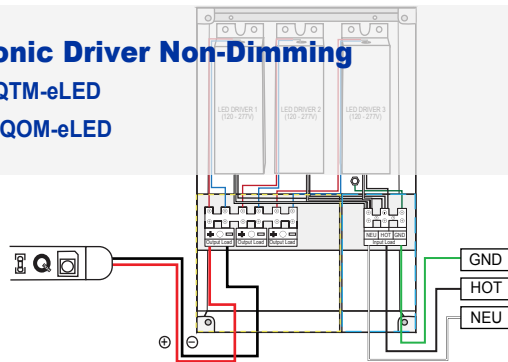

Electronic 0-10V Dimming

Interior: QTM-eLED+0-10V
Exterior: QOM-eLED+0-10V

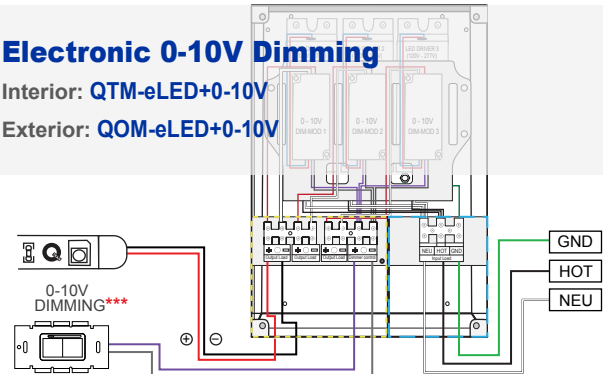

Magnetic Interior: Q6S-DC or QTM-DC (DC)** Exterior: QOM-DC

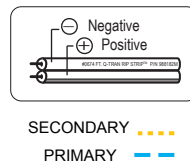
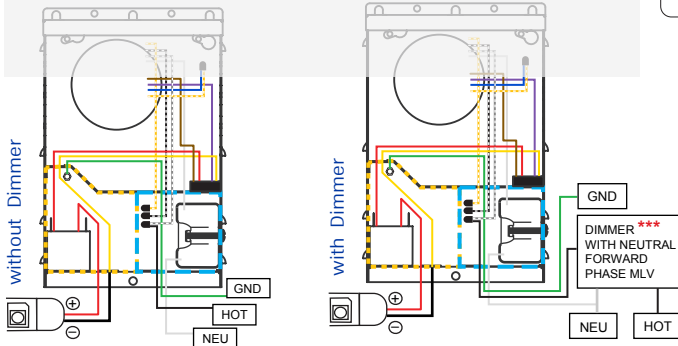

Magnetic Interior: Q6M-DC+CAP or QTM-DC+CAP (DC+CAP) Exterior: QOM-DC+CAP

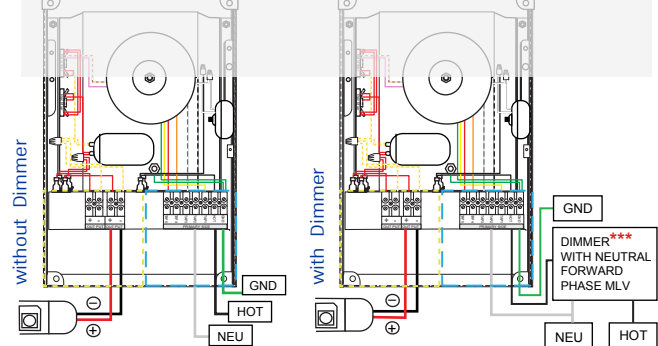

Phase Controlled Dimming

Interior and Exterior: iQ-PH

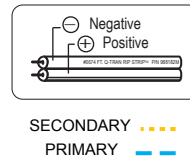
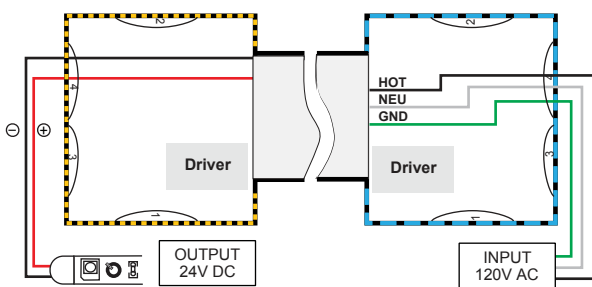

Electronic with 0-10V Dimming options

Exterior: Q-SET-eLED+0-10V

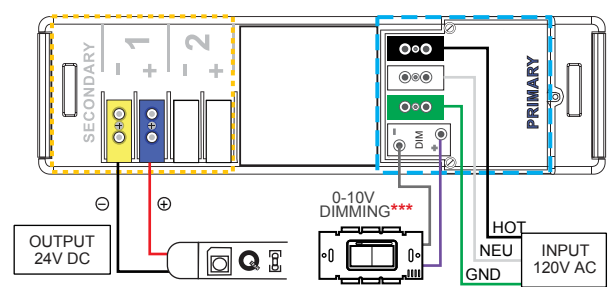

Electronic Power Supplies

Interior: QTM-eLED(E)

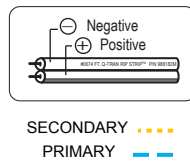
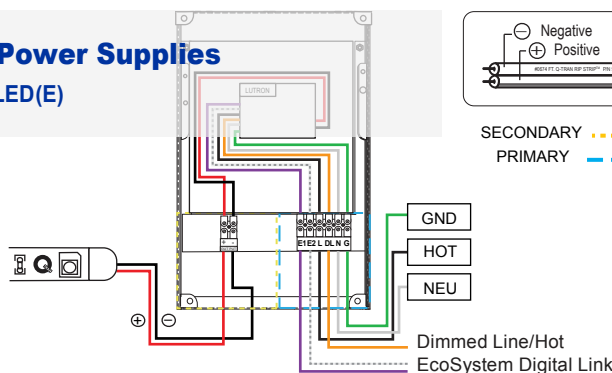

Electronic Power Supplies

Interior: QTM-eLED(L)

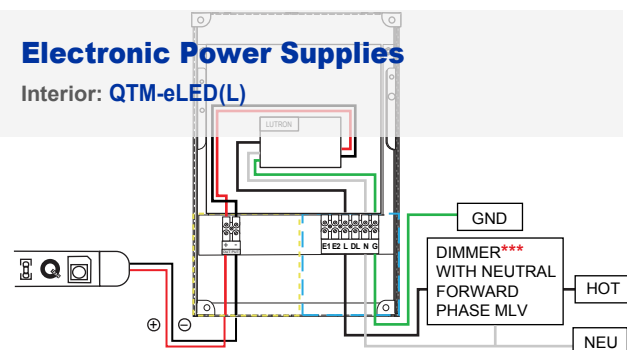

***Customer provided

Dimmed Line/Hot
EcoSystem Digital Link