



# iQLED IP66 WET RATED OUTERBEND

A versatile, flexible LED power strip that is bendable in a variety of different directions. Great light source for indoor and covered outdoor applications with a rating of IP66 which is water resistant to protect against the elements. Outerbend is offered in 2 Color Temperatures; 2700K & 3000K 2.6 watts per foot.

<b>iQ66</b>	-		-	<b>OBD</b>	-	<b>90</b>	-	<b>2.6</b>	-	
iQ Series		Color Temp		Type		CRI		Watt Per ft		Length

## iQ66-27-OBD-90-2.6

Max Run / Reel Length: 98ft\* | ColorTemp: 2700K | Voltage: 24VDC  
CRI: 90+ | LM: 79 | Watts Per Ft: 2.6 | Lumens Per Ft: 114

## iQ66-30-OBD-90-2.6

Max Run / Reel Length: 98ft\* | ColorTemp: 3000K | Voltage: 24VDC  
CRI: 90+ | LM: 79 | Watts Per Ft: 2.6 | Lumens Per Ft: 116

\*Maximum length for one run of iQ66 Outerbend 2.6. For runs greater than 49 feet, separate power feeds needed at each end. Power supply cut sheets will provide max distance/loads per power supply.

### FLEXIBILITY

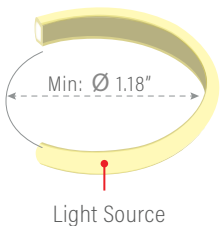

### FEATURES

- LED lifetime - 30,000 hours
- Operating temperature: -40°F ~ +176°F
- V-2 flame retardance
- Silicone housing is UV-resistant
- Ingress protection rating IP66(Dot-Free)
- Outdoor/indoor decoration lighting
- Decoration lighting, Architecture lighting
- Minimum bending diameter 1.18"
- 2.18" cut points
- 5 year warranty

### DIMENSIONS

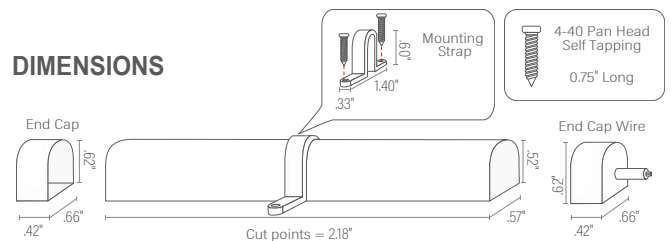

### COMPATIBLE POWER SUPPLIES

#### Interior Applications

- Q6S-DC
- Q6M-DC+CAP
- QTM-DC
- QTM-DC+CAP
- QTM-eLED
- QTM-eLED(L)
- QTM-eLED(E)
- iQ-PH

#### Exterior Applications

- QOM-eLED
- QOM-DC
- QOM-DC+CAP
- Q-SET-eLED
- iQ-PH

### CUTTING INSTRUCTIONS:

This flex light can be cut on the dotted line mapped on the unit at every 2.18"



2019 0315 - V01

PROJECT NAME	DATE	COMPANY	TYPE	NOTE



# iQLED IP66 WET RATED COLOR DATA

## 2700K



**CRI:** 92.5  
**CRI R9:** 58.9  
**TM30 Rf:** 89.9  
**TM30 Rg:** 96.4  
**CQS:** 90.6  
**X:** 0.462  
**Y:** 0.415  
**U:** 0.262  
**V:** 0.353  
**Δuv:** 0.0013

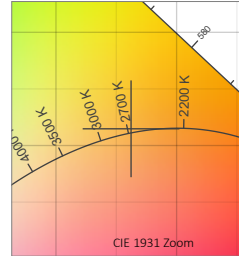
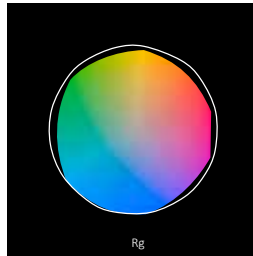
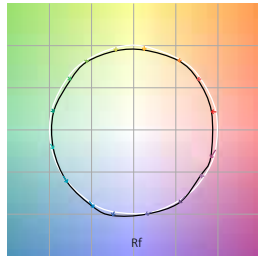

R1	R2	R3	R4	R5	R6	R7	R8	R9	R10	R11	R12	R13	R14	R15	
92.2	96.8	99.0	91.5	91.9	96.8	91.3	80.8	58.9	92.1	92.4	82.4	93.4	99.6	87.6	
Q1	Q2	Q3	Q4	Q5	Q6	Q7	Q8	Q9	Q10	Q11	Q12	Q13	Q14	Q15	
87.3	94.2	91.2	88.5	89.5	90.3	91.6	93.6	95.3	94.0	93.6	92.8	91.9	86.3	87.1	
C1	C2	C3	C4	C5	C6	C7	C8	C9	C10	C11	C12	C13	C14	C15	C16
88.1	91.0	91.8	91.7	94.1	95.3	92.1	93.1	88.8	86.5	88.2	90.0	90.2	86.9	89.7	84.0

TM30			
Hue Bin	R <sub>f</sub>	Chroma	Hue
1	88	-5%	1%
2	91	-3%	2%
3	92	-2%	3%
4	92	-4%	-1%
5	94	-4%	1%
6	95	-2%	1%
7	92	-4%	1%
8	93	-2%	3%
9	89	-2%	6%
10	87	0%	8%
11	88	3%	8%
12	90	5%	-1%
13	90	1%	-7%
14	87	2%	-9%
15	90	-4%	-2%
16	84	-4%	-10%

## 3000K



**CRI:** 91.2  
**CRI R9:** 65.0  
**TM30 Rf:** 90.5  
**TM30 Rg:** 99.3  
**CQS:** 90.2  
**X:** 0.447  
**Y:** 0.413  
**U:** 0.253  
**V:** 0.351  
**Δuv:** 0.0023

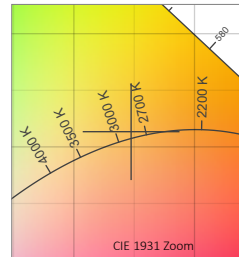
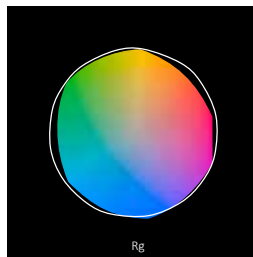
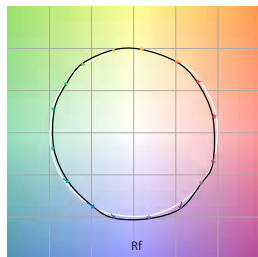

R1	R2	R3	R4	R5	R6	R7	R8	R9	R10	R11	R12	R13	R14	R15	
90.7	93.0	94.0	91.7	89.5	90.0	95.1	85.6	65.0	82.9	90.9	74.0	90.8	96.0	88.3	
Q1	Q2	Q3	Q4	Q5	Q6	Q7	Q8	Q9	Q10	Q11	Q12	Q13	Q14	Q15	
90.6	97.0	86.6	86.4	89.1	89.0	89.9	93.0	96.2	92.6	91.5	91.7	91.9	87.7	88.8	
C1	C2	C3	C4	C5	C6	C7	C8	C9	C10	C11	C12	C13	C14	C15	C16
90.6	91.4	87.7	91.7	94.0	95.2	92.9	95.7	92.8	87.3	84.5	87.8	93.6	89.0	92.0	85.8

TM30			
Hue Bin	R <sub>f</sub>	Chroma	Hue
1	91	-4%	-1%
2	91	-4%	2%
3	88	-2%	5%
4	92	-1%	4%
5	94	1%	3%
6	95	2%	0%
7	93	-1%	-3%
8	96	-2%	-1%
9	93	-3%	1%
10	87	-3%	7%
11	84	0%	10%
12	88	4%	5%
13	94	3%	-1%
14	89	6%	-5%
15	92	0%	-4%
16	86	-1%	-10%

**NOTES:**

- CRI R values, only R1-R8 are used to calculate RA CRI values
- TM30 C values, 16 binned values out of total of 99 C values
- CQS Q values
- Data subject to change, all data has +/- 5% tolerance



iQLED IP66 WET RATED

# COMPATIBLE POWER SUPPLIES

## Electronic Driver Non-Dimming

Interior: QTM-eLED

Exterior: QOM-eLED

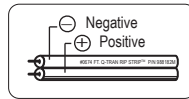
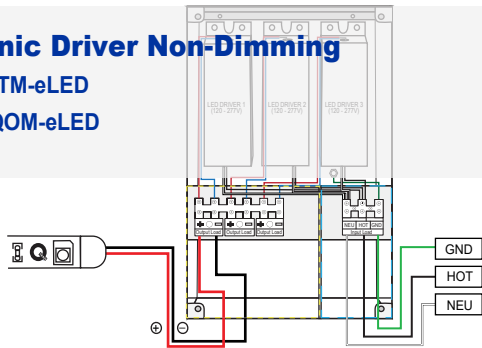

SECONDARY .....  
PRIMARY -----

## Electronic 0-10V Dimming

Interior: QTM-eLED+0-10V

Exterior: QOM-eLED+0-10V

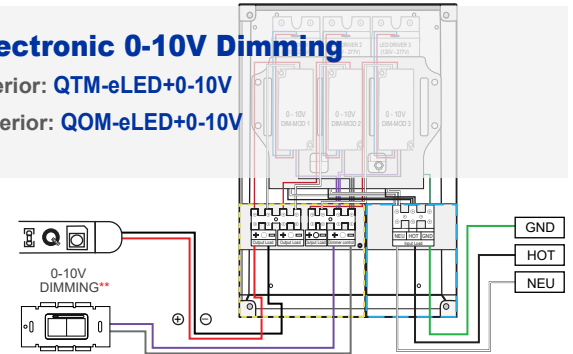

## Magnetic Interior: Q6S-DC or QTM-DC (DC) Exterior: QOM-DC

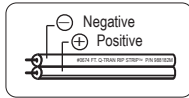
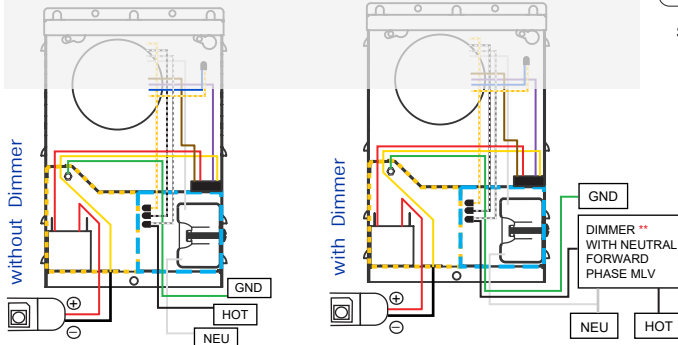

SECONDARY .....  
PRIMARY -----

## Magnetic Interior: Q6M-DC+CAP or QTM-DC+CAP (DC+CAP) Exterior: QOM-DC+CAP

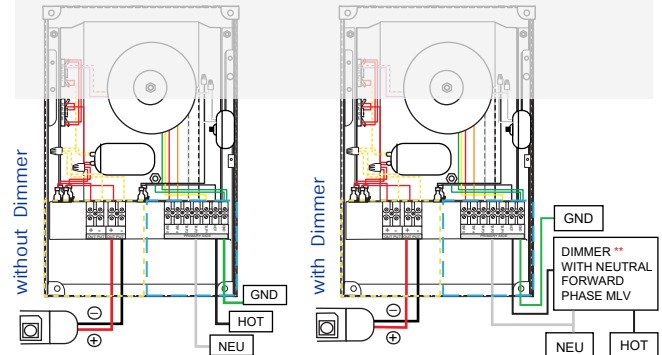

## Phase Controlled Dimming

Interior and Exterior: iQ-PH

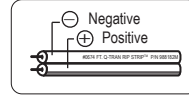
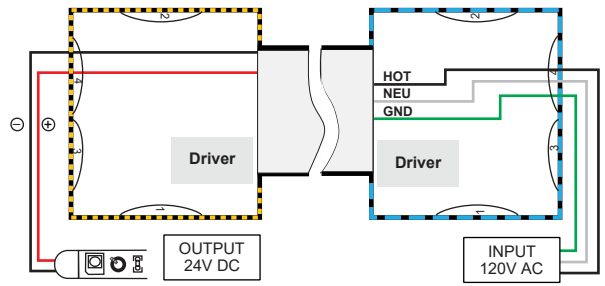

SECONDARY .....  
PRIMARY -----

## Electronic with 0-10V Dimming options

Exterior: Q-SET-eLED+0-10V

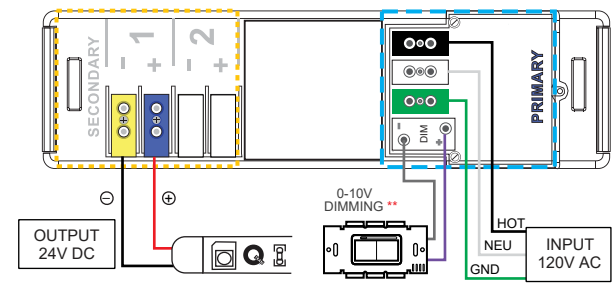

## Electronic Power Supplies

Interior: QTM-eLED(E)

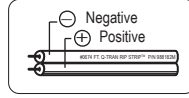
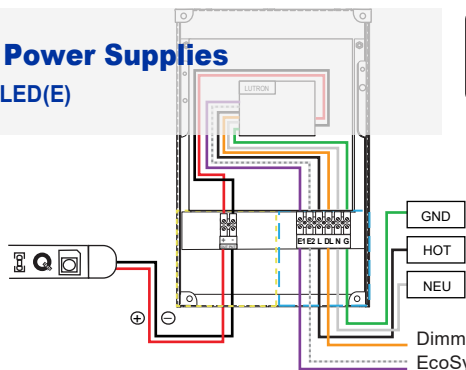

SECONDARY .....  
PRIMARY -----

## Electronic Power Supplies

Interior: QTM-eLED(L)

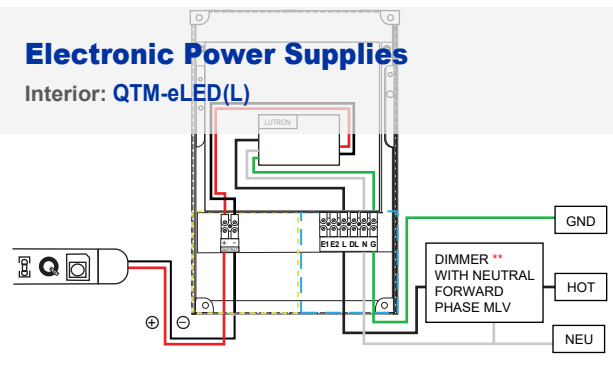

\*\*Customer provided